

Flex Spray Station™ Kit 2: Straight Rail

Allows 30 parts to be processed at a time

Kit SKU: GSP-MB-1003

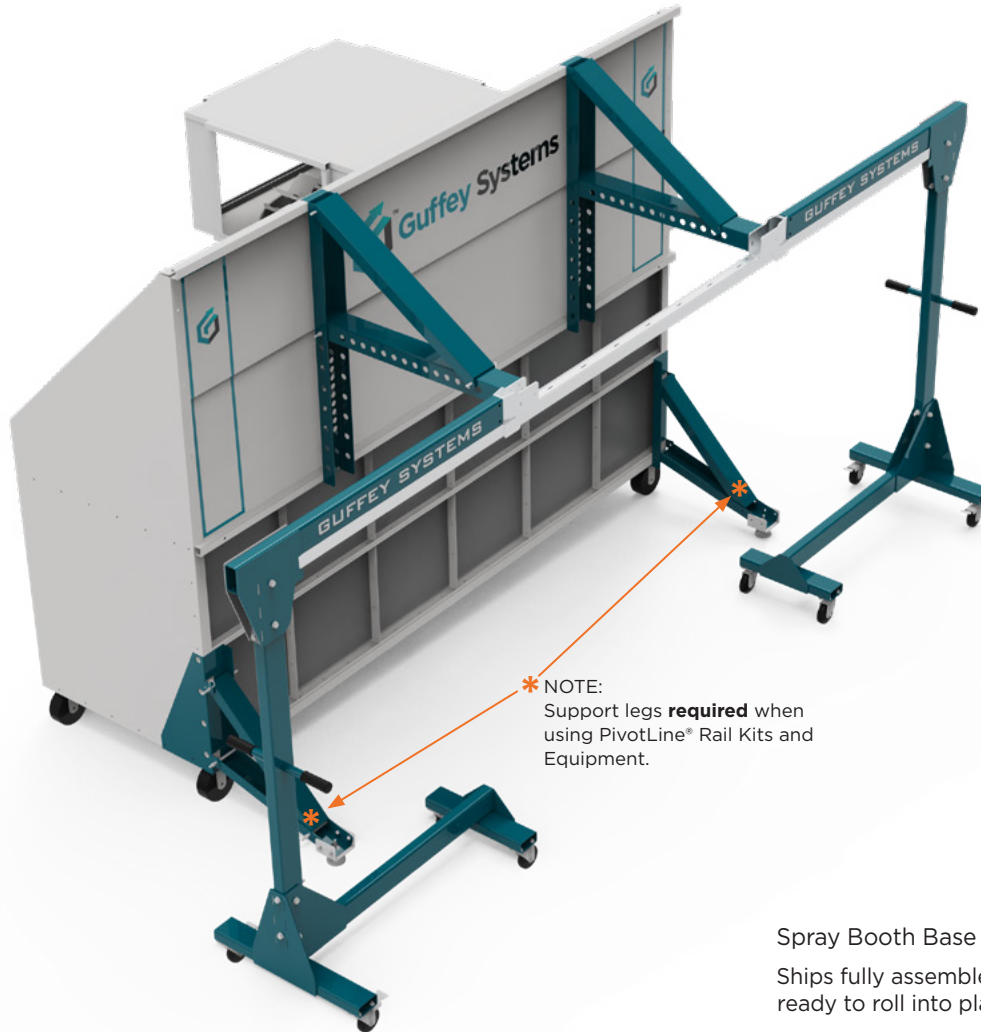

* NOTE:
Support legs **required** when
using PivotLine® Rail Kits and
Equipment.

Spray Booth Base Price \$13,500

Ships fully assembled and
ready to roll into place











Flex Spray Station – Straight Rail Kit 2

- Equipped with rail mounting brackets
- Rail mounting brackets are slidable for left/right adjustment in case a customer needs to reduce the length of the spray rail, and they can be completely removed if needed
- Rail is equipped with rail end couplers at each end to attach rail to rail mounting brackets
- Rail end couplers allow the connection of mobile rails to the stationary rail
- Equipped with enough mobile rails, rolling spray hubs, hangers, and accessories to process around 30 parts at a time

CODE COMPLIANCE: The spray booth is designed to meet manufactures and designs applicable industry codes and standards. Please be aware that local requirements may vary from national codes. Please consult local authorities before purchasing paint booths.

- Reference NFPA 33 and Chapter 24 of the International Fire Code (IFC) for spray applications using flammable and combustible materials
- Reference NFPA 86 and Chapter 30 of the IFC for curing and drying applications
- Many components and product lines are ETL and ETL-C listed. The ETL or ETL-C mark is proof of compliance with North American safety standards, including UL, NFPA, OSHA and more
- A UL or CUL listing verifies that Underwriters Laboratories has tested RGI' product and determined that it meets their stringent safety and performance requirements









PIVOTLINE
Manual-Rail Finishing System

Description	Qty	Rate	Amt
PivotLine Stationary Rail Kit Complete 1 - Aluminum rail - 6 ft. length* 2 - Rail Mounting Brackets 2 - Mobile Couplers * 6 ft. rails can easily be cut to shorter length if needed 	1	\$3,070.00	\$3,070.00
Support Legs Support legs required when using PivotLine® Rail Kits and Equipment Set of 2 legs 	1 set of 2 legs	\$1,250.00	\$1,250.00
Mobile Rail - Compact Used for loading, off-loading, drying, and storage of parts. A key component for maximizing PivotLine efficiency and reducing material handling 	2	\$1,875.00	\$3,750.00
Rolling Spray Hub Rolls smoothly and pivots in 90° increments allowing for easy spraying of all sides 	12	\$84.00	\$1,008.00
Twist Stop Insert into stationary and mobile rails to prevent unwanted movement of materials 	4	\$89.00	\$356.00
T-Bar - Short (17") Hang doors using EFC or Offset Hangers. Group multiple parts together by hanging Offset and Universal Hangers across top of T-Bars 	4	\$25.00	\$100.00
T-Bar - Medium (34") Hang doors using EFC or Offset Hangers. Group multiple parts together by hanging Offset and Universal Hangers across top of T-Bars 	8	\$42.00	\$336.00
T-Bar - Large (46") Hang doors using EFC or Offset Hangers. Group multiple parts together by hanging Offset and Universal Hangers across top of T-Bars 	8	\$56.00	\$448.00
Offset Hanger w/screws For hanging drawer fronts, face frames, and other miscellaneous components 	20	\$11.20	\$224.00
Universal Hanger w/screws For hanging shelves, face frames, and other miscellaneous components 	10	\$11.20	\$112.00
EFC (Spring Clip) For hanging panels from hinge pockets to hang on T-Bars 	60	\$1.50	\$90.00

* Part/parts refers to the number of items being processed, not the number of equipment components in the kit.

* To increase capacity of the system see next page Kit Add-ons.

Equipment subtotal	\$10,744.00
Spray Booth subtotal	\$13,500.00
Total	\$24,244.00

Description	Qty	Rate	Amt
Mobile Rail - Compact Used for loading, off-loading, drying, and storage of parts. A key component for maximizing PivotLine efficiency and reducing material handling 	1	\$1,875.00	\$1,875.00
Rolling Spray Hub Rolls smoothly and pivots in 90° increments allowing for easy spraying of all sides 	12	\$84.00	\$1,008.00
Twist Stop Insert into stationary and mobile rails to prevent unwanted movement of materials 	1	\$89.00	\$89.00
T-Bar - Short (17") Hang doors using EFC or Offset Hangers. Group multiple parts together by hanging Offset and Universal Hangers across top of T-Bars 	4	\$25.00	\$100.00
T-Bar - Medium (34") Hang doors using EFC or Offset Hangers. Group multiple parts together by hanging Offset and Universal Hangers across top of T-Bars 	8	\$42.00	\$336.00
T-Bar - Large (46") Hang doors using EFC or Offset Hangers. Group multiple parts together by hanging Offset and Universal Hangers across top of T-Bars 	8	\$56.00	\$448.00
Offset Hanger w/screws For hanging drawer fronts, face frames, and other miscellaneous components 	20	\$11.20	\$224.00
Universal Hanger w/screws For hanging shelves, face frames, and other miscellaneous components 	10	\$11.20	\$112.00
EFC (Spring Clip) For hanging panels from hinge pockets to hang on T-Bars 	60	\$1.50	\$90.00

* Part/parts refers to the number of items being processed, not the number of equipment components in the kit.

Total	\$4,282.00
--------------	-------------------

Flex Spray Station™

Spray Booth only – does not include rail kit or spray equipment

SKU PL-MBK-10

- **Construction:** 18 ga. zinc galvanized steel panels, pre-punched, assembled with 1/4 nuts and bolts
- **Post exhaust filters:** Pocket Filters *
Part number: EPB-202515/3P
20" x 25" x 15" B/W 3PKT Bag Filter 3/CS
Filter life: 300 hours of use
- **Exhaust filters:** Paint Pocket Filters
Part number: PP-020-020-030
20" x 20" Paint Pockets - Original - 30/CS
Filter life: Up to 125 hrs of use
- **Mechanical:** Heavy-duty tube axial type with non-sparking aluminum blades, enclosed belts and ball bearings
- (1) 2hp 3 phase 208-240 volt motor
- (1) 220v connection
- Delivers: 12,095 cfm @ 0.250" s.p.
- AC motor speed control
- Adjustable frequency drive 1 & 3 phase input. 3ph output ac motors NEMA 4x / ip 65
- NEMA 6-20p 20 amp
250v 3 prong plug
- For use with water or solvent-based coatings
- **IMPORTANT:**
 - A Ducting Kit for venting to the outside is **required for** use with **solvent-based coatings**.
 - When using **water-based coatings**, the booth can be used as a recirculating unit, **requiring no ducting** to the outside.
- Equipped with locking casters

NOTE:
Post Exhaust
Filters not
shown.



Spray Booth Base Price \$13,500

Ships fully assembled and ready to roll into place

CODE COMPLIANCE: The spray booth is designed to meet manufactures and designs applicable industry codes and standards. Please be aware that local requirements may vary from national codes. Please consult local authorities before purchasing paint booths.

- Reference NFPA 33 and Chapter 24 of the International Fire Code (IFC) for spray applications using flammable and combustible materials
- Reference NFPA 86 and Chapter 30 of the IFC for curing and drying applications
- Many components and product lines are ETL and ETL-C listed. The ETL or ETL-C mark is proof of compliance with North American safety standards, including UL, NFPA, OSHA and more
- A UL or CUL listing verifies that Underwriters Laboratories has tested RGI' product and determined that it meets their stringent safety and performance requirements

Flex Spray Station™

Spray Booth only – does not include rail kit or spray equipment

SKU PL-MBK-10

- **Spray Booth Construction:**

18 ga. zinc galvanized steel panels,
pre-punched, assembled with
1/4 nuts and bolts

- **Post exhaust filters:**

(3) 20" x 25" Pocket Filters

- **Exhaust filters:**

(12) 20" x 20" Paint Pocket Filters

- **Mechanical:** Heavy-duty tube axial type
with non-sparking aluminum blades,
enclosed belts and ball bearings

- (1) 2hp 3 phase 208-240 volt motor

- (1) 220v connection

- Delivers: 12,095 cfm each @ 0.250" s.p.

- AC motor speed control

- Adjustable frequency drive 1 & 3 phase input
3ph output ac motors NEMA 4x / ip 65

- NEMA 6-20p 20 amp 250v 3 prong plug

- **Filter maintenance:**

Front filters:

Change after every 100-125 hours of use

Pocket filters:

Change after every 300 hours of use

TOP VIEW:

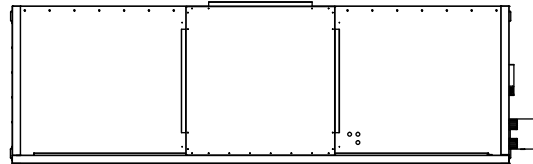

FRONT VIEW:

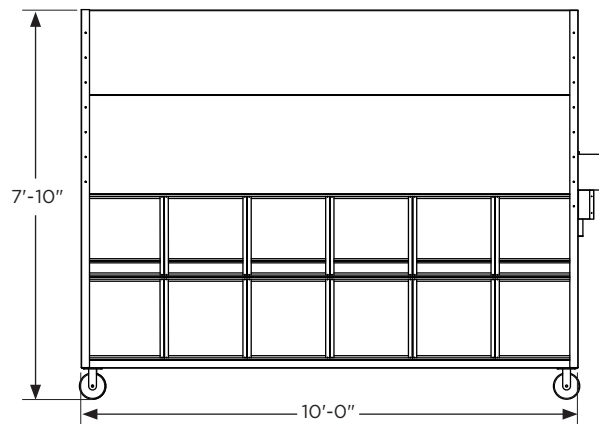

SIDE VIEW:

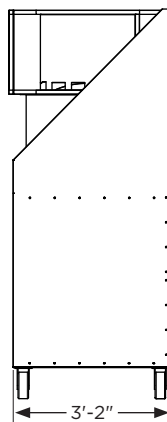

SIDE VIEW:

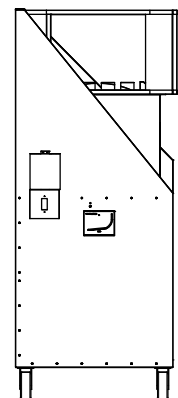

Flex Spray Station™

Spray Booth Box Filter Louver Assembly

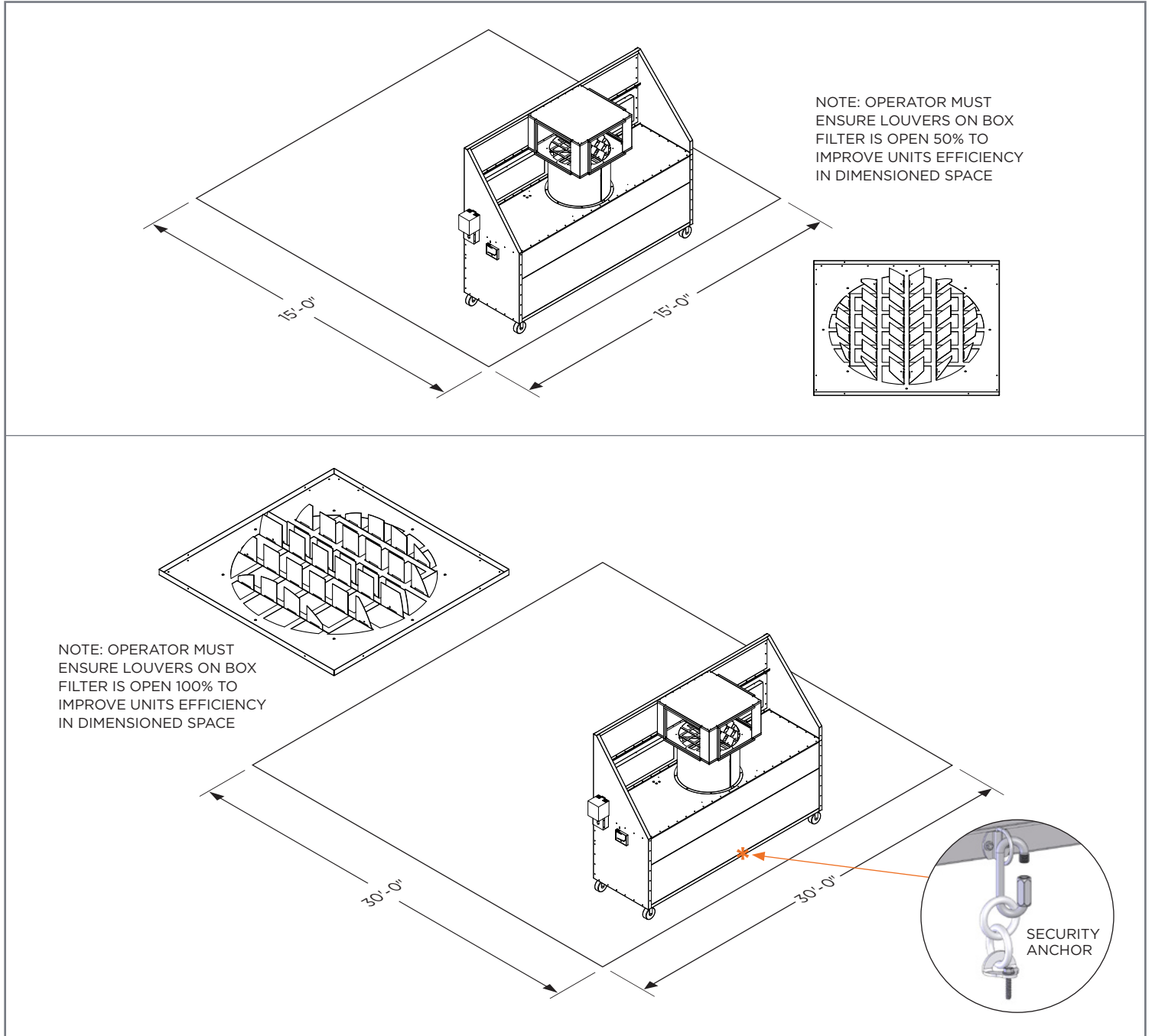

Flex Spray Station™

Spray Booth Wall Ducting Kit

QTY	DESCRIPTION
2	DUCT 48" LONG 20GA
1	FAN
1	RING 2" HEIGHT
1	DUCT INSPECTION 48" LONG 20GA
1	DUCT INSPECTION COVER 20GA
1	DUCT FLASHING DUCT DIAMETER + 6" 20GA 15" HEIGHT
1	DUCT DAMPER ASSEMBLY
2	DUCT 90 DEG ELBOW

Wall Ducting Kit: Use when needing to exhaust through a wall. Ducting configuration may vary depending on each shop's setup and codes.

IMPORTANT:

- A Ducting Kit for venting to the outside is **required for** use with **solvent-based coatings**.
- When using **water-based coatings**, the booth can be used as a recirculating unit, **requiring no ducting** to the outside.

NOTES:

- 1) MALE (CRIMPED END) OF DUCT MUST BE UP & FEMALE END IS DOWN
- 2) FIRE WRAP IS USED ON WOODEN ROOFS
- 3) ALLOW 2" FOR EACH CONNECTION
- 4) NUMBER OF DUCTS WILL VARY

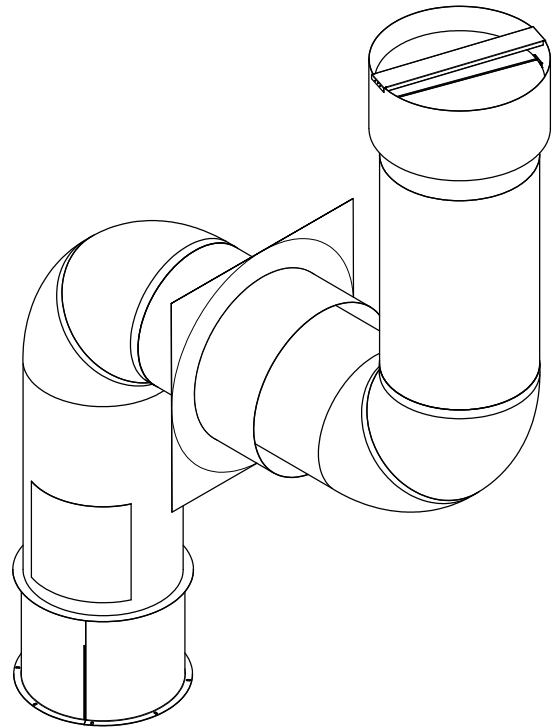
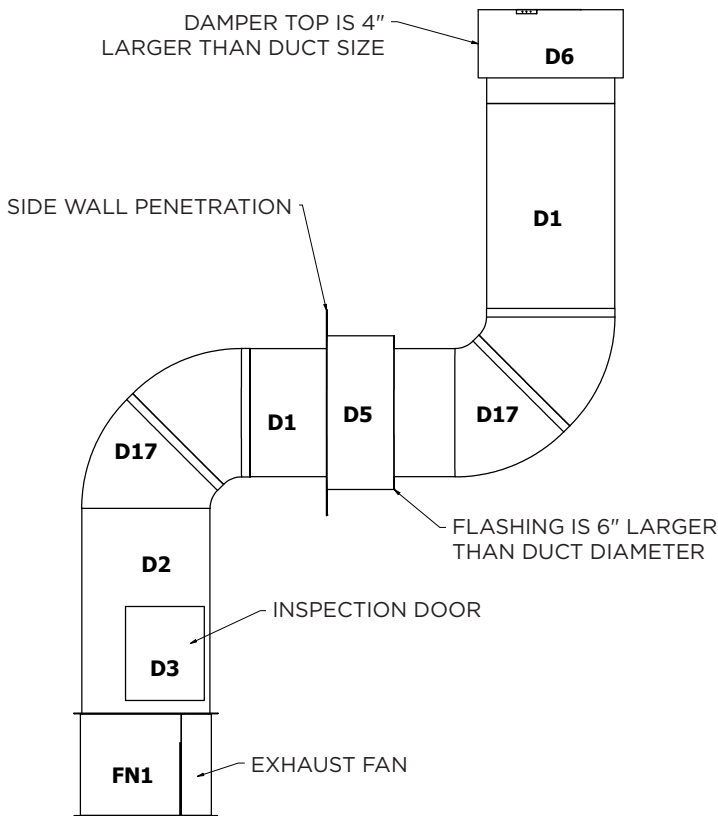

Flex Spray Station™

Spray Booth Roof Ducting Kit

QTY	DESCRIPTION
2	DUCT 48" LONG 20GA
1	FAN
1	RING 2" HEIGHT
1	DUCT INSPECTION 48" LONG 20GA
1	DUCT INSPECTION COVER 20GA
4	DUCT QUARTER SECTION SKIRT (COLLAR) 20GA
1	DUCT FLASHING DUCT DIAMETER + 6" 20GA 15" HEIGHT
1	DUCT DAMPER ASSEMBLY

Roof Ducting Kit: Use when needing to exhaust through a roof. Ducting configuration may vary depending on each shop's setup and codes.





IMPORTANT:

- A Ducting Kit for venting to the outside is **required for use with solvent-based coatings.**
- When using **water-based coatings**, the booth can be used as a recirculating unit, **requiring no ducting** to the outside.

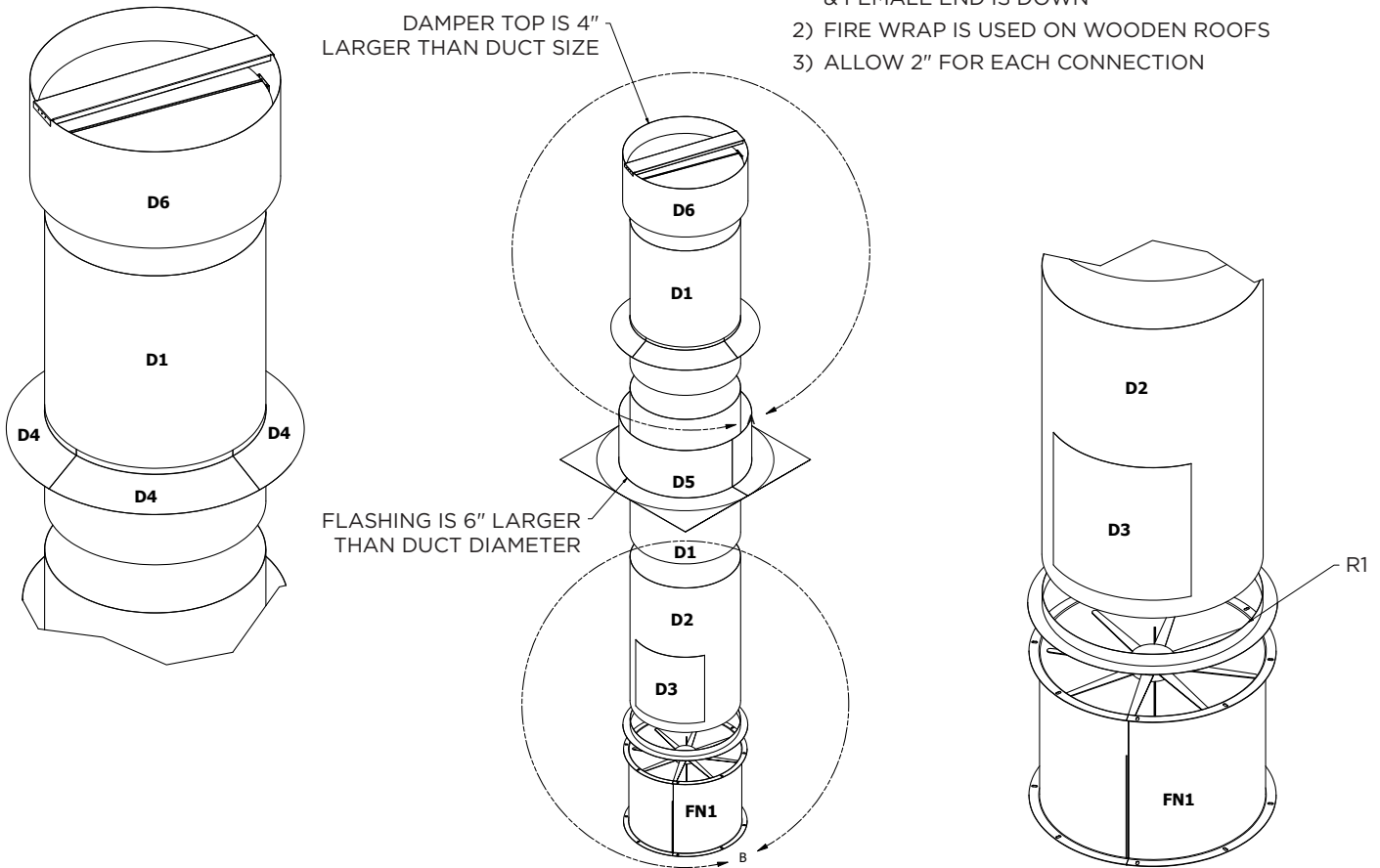
NOTES:

- 1) MALE (CRIMPED END) OF DUCT MUST BE UP & FEMALE END IS DOWN
- 2) FIRE WRAP IS USED ON WOODEN ROOFS
- 3) ALLOW 2" FOR EACH CONNECTION

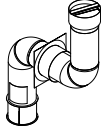

Description	Qty	Rate	Amt
Support Legs Support legs required when using PivotLine® Rail Kits and Equipment Set of 2 legs	 1 set of 2 legs	\$1,250.00	\$1,250.00
Pocket Filters - Filters on Back of Unit at Fan Housing Part number: EPB-202515/3P 20" x 25" x 15" B/W 3PKT Bag Filter 3/CS Filter life: 300 hours of use	 1	\$265.00	\$265.00
Paint Pocket Filters - Front Filters Part number: PP-020-020-030 20" x 20" Paint Pockets - Original - 30/CS Filter life: Up to 125 hours of use	 1	\$155.76	\$155.76
Wall Ducting Kit Configured and priced accordingly for each shop	 1	\$	\$
Roof Ducting Kit Configured and priced accordingly for each shop	 1	\$	\$